

iii·PRO

Important Information

Network Disk Recorder

Model No. **WJ-NU101K Series**
WJ-NU201K Series
WJ-NU300K Series

For professional use only

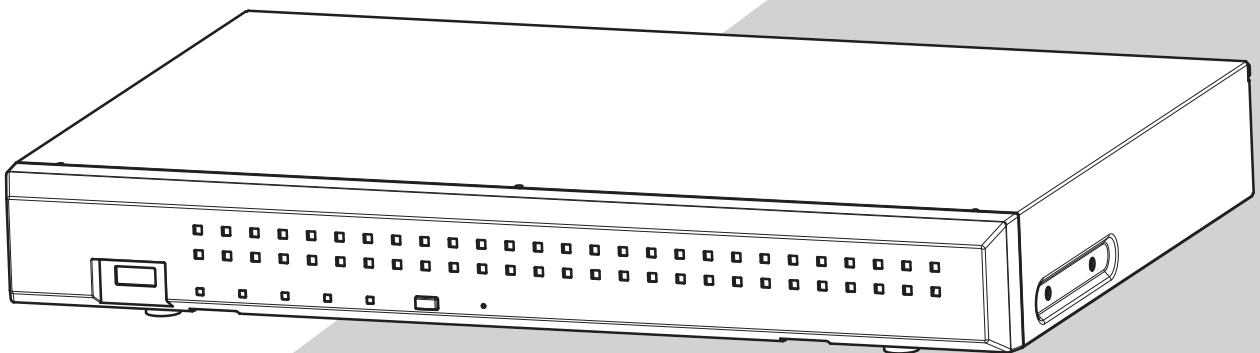

WJ-NU101K Series refer to WJ-NU101K, WJ-NU101KG and WJ-NU101KGV.
WJ-NU201K Series refer to WJ-NU201K, WJ-NU201KG and WJ-NU201KGV.
WJ-NU300K Series refer to WJ-NU300K, WJ-NU300KG and WJ-NU300KGV.

HDMI[®]
HIGH-DEFINITION MULTIMEDIA INTERFACE

Before attempting to connect or operate this product,
please read these instructions carefully and save this manual for future use.

The model number is abbreviated in some descriptions in this manual.

Safety Information

Caution:

- This recorder is only intended for a connection to an ethernet or PoE network without routing to the outside plant.
- This product has no power switch. Be sure to install disconnect devices such as a circuit breaker to shut down the main power of power supplying equipment to this product.
- Before attempting to connect or operate this product, please read these instructions carefully.

WARNING:

- All work related to the installation and earthing of this product should be made by qualified service personnel or system installers.
- Operation of this product in a residential environment could cause radio interference.

Notice:

- This product is not suitable for use in locations where children are likely to be present.
- For information about screws and other parts required for installation, refer to the corresponding section of this document.
- The power supply cord is used as the main disconnect device, ensure that the socket-outlet is located/installed near the equipment and is easily accessible.
- This product is a professional equipment.



: Functional earthing; functional grounding(US) symbol



: Direct current symbol



: Alternation current symbol



: Polarity of d.c. power connector



: For indoor use only



: Computer network



: Mouse port



: USB port

For U.S.A.

This device complies with part 15 of the FCC Rules. Operation is subject to the following two conditions: (1) This device may not cause harmful interference, and (2) this device must accept any interference received, including interference that may cause undesired operation.

For U.S.A.

Supplier's Declaration of conformity Trade

Name: i-PRO

Model No. : WJ-NU101K, WJ-NU201K,
WJ-NU300K

Responsible Party: i-PRO Americas Inc.

8550 Fallbrook Drive, Suite 200

Houston,

Texas 77064

Support Contact: 1-800-513-5417



For U.S.A.

The model number and serial number of this product may be found on the surface of the unit. You should note the model number and serial number of this unit in the space provided and retain this book as a permanent record of your purchase to aid identification in the event of theft.

Model No. _____

Serial No. _____

For Canada

CAN ICES-3(A)/NMB-3(A)

For U.S.A.

Note: This equipment has been tested and found to comply with the limits for a Class A digital device, pursuant to Part 15 of the FCC Rules. These limits are designed to provide reasonable protection against harmful interference when the equipment is operated in a commercial environment. This equipment generates, uses, and can radiate radio frequency energy and, if not installed and used in accordance with the instruction manual, may cause harmful interference to radio communications. Operation of this equipment in a residential area is likely to cause harmful interference in which case the user will be required to correct the interference at his own expense.

FCC Caution:

Changes or modifications not expressly approved by the party responsible for compliance could void the user's authority to operate the equipment.

Make sure to use the included AC power adapter.

Fixing screw

Installation method	Recommended screw	Minimum pull-out strength
Mount the recorder on the wall	M5, 10mm {13/32 inches}	196 N {44 lbf}

When installing the recorder on a wall, the height should be no more than 2 m {6.6 ft}.

Safety Information (continued)



For U.K.

FOR YOUR SAFETY PLEASE READ THE FOLLOWING TEXT CAREFULLY.

This appliance is supplied with a moulded three pin mains plug for your safety and convenience.

A 5 amp fuse is fitted in this plug.

Should the fuse need to be replaced please ensure that the replacement fuse has a rating of 5 amp and that it is approved by ASTA or BSI to BS1362.

Check for the ASTA mark  or the BSI mark  on the body of the fuse.

If the plug contains a removable fuse cover you must ensure that it is refitted when the fuse is replaced.

If you lose the fuse cover the plug must not be used until a replacement cover is obtained.

A replacement fuse cover can be purchased from your local our dealer.

IF THE FITTED MOULDED PLUG IS UNSUITABLE FOR THE SOCKET OUTLET IN YOUR HOME THEN THE FUSE SHOULD BE REMOVED AND THE PLUG CUT OFF AND DISPOSED OF SAFELY. THERE IS A DANGER OF SEVERE ELECTRICAL SHOCK IF THE CUT OFF PLUG IS INSERTED INTO ANY 13 AMP SOCKET.

How to replace the fuse

The location of the differs according to the type of AC mains plug (figures A and B).

Confirm the AC mains plug fitted and follow the instructions below. Illustrations may differ from actual AC mains plug.

Open the fuse cover with a screwdriver and replace the fuse and close or attach the fuse cover.

Figure A

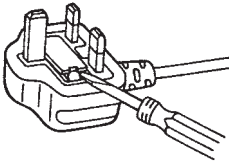
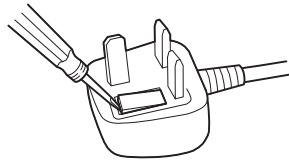

Figure B



Contents

Safety Information	2
Introduction	5
Preface	5
Features	5
System requirements for a PC	7
Trademarks and registered trademarks	7
About HEVC (High Efficiency Video Coding) patents	7
Copyright	7
Disclaimer of warranty	8
Network security	8
Limitation of liability	8
Precautions	9
Major operating controls and their functions	12
Front view.....	12
Rear view	13
User/Host management	15
When operating from a PC via a network	15
Specifications	16

Introduction

Preface

The network disk recorders WJ-NU101K Series, WJ-NU201K Series, WJ-NU300K Series (hereinafter, recorder) equipped H.265 CODEC and are designed for use within a H.265 surveillance system, and record images/audio from 4 to 16 network cameras (hereinafter, cameras) on the hard disk drives (HDDs).

This recorder supports connection with a monitor equipped with the HDMI (High-Definition Multimedia Interface) connector. Connection using an HDMI cable (optional) offers display of playback/live images with superior quality. It is possible to display images from multiple cameras, switch those images and perform basic operation of the camera.

"WJ-NU101", "WJ-NU201", and "WJ-NU300" in this manual refer to WJ-NU101K Series, WJ-NU201K Series, WJ-NU300K Series respectively.

Features

High-definition image monitoring is available

Images from 4 to 16 cameras with the image capture size of 4K can be saved as video data.

This recorder also supports the HDMI output to 2 monitors that can display recorded images and live images from the cameras in high definition.

Quick setup and operations

By connecting a mouse (accessory) to this recorder, quick operations are available while viewing a monitor.

By using "Easy Start", the cameras are automatically recognized and settings can be configured without operations from a PC*. Recorded images can easily be searched using calendar or time line.

* A PC will be necessary for some of the camera settings and viewing the instruction manual.

The copy port equipped

You can copy the images recorded on the camera with an external HDD and USB memory (sold separately).

The copied images can be played, printed or saved using the dedicated viewer software.

From 4 to 16 cameras can be connected and recorded

This model (New function) is equipped with 4 (WJ-NU101) and 8 (WJ-NU201, WJ-NU300) camera ports with PoE+ power supply function compliant with IEEE802.3at, which can enable connection and recording of up to 4 and 8 cameras respectively.

The WJ-NU300 series can connect and record up to 16 cameras by using a PoE+ Network switch (locally procured).

Third-party cameras can be connected (New function)

In addition to our cameras, third-party ONVIF® compatible cameras can be connected. Third-party cameras can also be connected via RTSP by specifying the URL.

* ONVIF is a trademark of ONVIF, Inc.

Contact input/output can be assigned in the setting menu (New function)

Equipped with two general-purpose contact input/output terminals, it is free to assign input/output functions from the setting menu of this product.

Protection against power failure

The built-in function protects the equipment and recorded data in the event of AC power interruption such as sudden power failure. This function makes it possible to turn off the AC power without having to stop recording or perform other operations.

*It does not guarantee that the equipment will not malfunction in the event of all possible power interruptions.

In addition, there is a possibility that the data recorded immediately prior to the power failure will not be saved.

If it is necessary to guarantee the operation of the equipment or to continue recording operation even in the event of a power failure, use an uninterruptible power supply or similar device in combination.

System Configuration

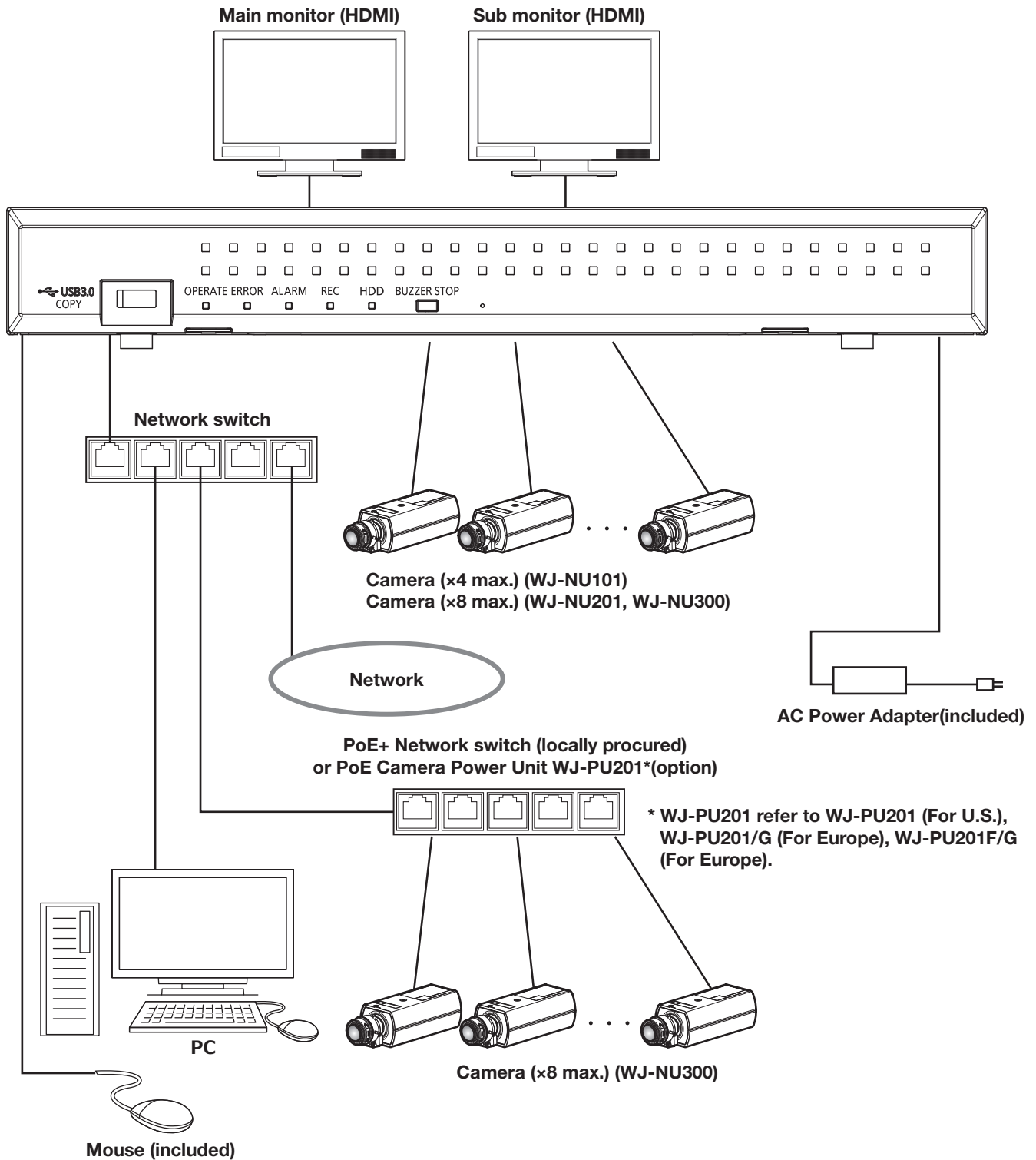

System requirements for a PC

It is recommended to operate this unit using a PC that meets the following system requirements.

OS:	Microsoft Windows 10, Microsoft Windows 11
Web browser:	Microsoft Edge, Google Chrome™, Mozilla Firefox
CPU:	Intel® Core™ i7-860
Memory:	4 GB or more
Monitor:	1024 × 768 pixels or more, 24-bit True color or better
Network interface:	10BASE-T/100BASE-TX/1000BASE-T 1 port
Audio:	Sound card (When using the audio function)
Others:	DirectX® 9.0c or later Adobe® Reader® or Acrobat Reader® (for viewing the Operating Instructions (PDF file))

Important:

- Refer to our support website (https://i-pro.com/global/en/surveillance/training_support/support/technical_information) for information about the latest operation verification of the supported operating systems and web browsers.
- If using a PC that does not meet the above system requirements, it may cause problems such as slow imaging or the browser becomes inoperable.

Trademarks and registered trademarks

- Adobe, Acrobat, and Reader are either registered trademarks or trademarks of Adobe in the United States and/or other countries.
- Microsoft, ActiveX, DirectX, Edge and Windows are either registered trademarks or trademarks of Microsoft Corporation in the United States and/or other countries.
- Microsoft product screen shot(s) reprinted with permission from Microsoft Corporation.
- Intel and Intel Core are trademarks of Intel Corporation or its subsidiaries in the U.S. and/or other countries.
- Google Chrome are trademarks of Google LLC.
- Firefox is a trademark of the Mozilla Foundation in the US and other countries.
- The terms HDMI, HDMI High-Definition Multimedia Interface, and the HDMI Logo are trademarks or registered trademarks of HDMI Licensing Administrator, Inc. in the United States and other countries.
- All other trademarks identified herein are the property of their respective owners.

About HEVC (High Efficiency Video Coding) patents

Covered by one or more claims of the HEVC patents listed at patentlist.accessadvance.com.

Copyright

Except for open source software licensed under GPL/LGPL and so on, distributing, copying, disassembling, reverse compiling and reverse engineering of the software provided with this product are all expressly prohibited. In addition, exporting any software provided with this product violating export laws is prohibited.

Disclaimer of warranty

IN NO EVENT SHALL i-PRO Co., Ltd. BE LIABLE TO ANY PARTY OR ANY PERSON, EXCEPT FOR REPLACEMENT OR REASONABLE MAINTENANCE OF THE PRODUCT, FOR THE CASES, INCLUDING BUT NOT LIMITED TO BELOW:

- (1) ANY LOSS OR DAMAGE, INCLUDING WITHOUT LIMITATION, DIRECT OR INDIRECT, SPECIAL, CONSEQUENTIAL OR EXEMPLARY, ARISING OUT OF OR RELATING TO THE PRODUCT;
- (2) ANY INCONVENIENCE, LOSS, OR DAMAGE CAUSED BY INAPPROPRIATE USE OR NEGLIGENT OPERATION OF THE USER;
- (3) ALL MALFUNCTIONS OR TROUBLES FROM UNAUTHORIZED DISASSEMBLE, REPAIR OR MODIFICATION OF THE PRODUCT BY THE USER, REGARDLESS OF THE CAUSE OF THE MALFUNCTION OR TROUBLE;
- (4) INCONVENIENCE OR ANY LOSS ARISING WHEN IMAGES ARE NOT DISPLAYED, DUE TO ANY REASON OR CAUSE INCLUDING ANY FAILURE OR PROBLEM OF THE PRODUCT;
- (5) ANY PROBLEM, CONSEQUENTIAL INCONVENIENCE, OR LOSS OR DAMAGE, ARISING OUT OF THE SYSTEM COMBINED BY THE DEVICES OF THIRD PARTY;
- (6) ANY CLAIM OR ACTION FOR DAMAGES BROUGHT BY ANY PERSON OR ORGANIZATION AS A PHOTOGRAPHED SUBJECT DUE TO VIOLATION OF PRIVACY CONCERNING A SURVEILLANCE CAMERA'S PICTURE OR SAVED DATA, FOR SOME REASON (INCLUDING USE WHEN USER AUTHENTICATION ON THE AUTHENTICATION SETTING SCREEN IS SET TO OFF), BECOMING PUBLIC OR BEING USED FOR ANY PURPOSE;
- (7) LOSS OF REGISTERED DATA CAUSED BY ANY FAILURE (INCLUDING INITIALIZATION OF THE PRODUCT DUE TO FORGOTTEN AUTHENTICATION INFORMATION SUCH AS A USER NAME AND PASSWORD).

Network security

As you will use this unit connected to a network, your attention is called to the following security risks.

- ① Leakage or theft of information through this unit
- ② Use of this unit for illegal operations by persons with malicious intent
- ③ Interference with or stoppage of this unit by persons with malicious intent
 - It is your responsibility to take precautions such as those described below to protect yourself against the above network security risks.
 - Use this unit in a network secured by a firewall, etc.
 - If this unit is connected to a network that includes PCs, make sure that the system is not infected by computer viruses or other malicious entities (using a regularly updated anti-virus program, anti-spyware program, etc.).
 - Protect your network against unauthorized access by restricting users to those who log in with an authorized user name and password set by using user authentication.
 - Apply measures such as user authentication to protect your network against leakage or theft of information, including image data, authentication information (user names and passwords), alarm mail information, FTP server information and DDNS server information.
 - After the unit is accessed by the administrator, make sure to close the browser.
 - Change the administrator password periodically. Keep the authentication information (your user name and password) in a safe place free from public view.
 - Do not install the camera in locations where the camera or the cables can be destroyed or damaged by persons with malicious intent.

Limitation of liability

THIS PUBLICATION IS PROVIDED "AS IS" WITHOUT WARRANTY OF ANY KIND, EITHER EXPRESS OR IMPLIED, INCLUDING BUT NOT LIMITED TO, THE IMPLIED WARRANTIES OF MERCHANTABILITY, FITNESS FOR ANY PARTICULAR PURPOSE, OR NON-INFRINGEMENT OF THE THIRD PARTY'S RIGHT.

THIS PUBLICATION COULD INCLUDE TECHNICAL INACCURACIES OR TYPOGRAPHICAL ERRORS.

CHANGES ARE ADDED TO THE INFORMATION HEREIN, AT ANY TIME, FOR THE IMPROVEMENTS OF THIS PUBLICATION AND/OR THE CORRESPONDING PRODUCT (S).

Precautions

Refer installation work to the dealer.

Installation work requires technique and experiences. Failure to observe this may cause fire, electric shock, injury, or damage to the product.

- Be sure to consult the dealer.

Do not disassemble nor alter this product.

Failure to observe this may cause fire or electric shock.

- Ask your dealer for inspection and repair.

Do not insert any foreign objects.

Do not allow any foreign object or liquid such as water, a metallic part, etc. to enter since it may cause fire or electric shock.

- If it happens, disconnect the power plug from the electric outlet immediately and contact your dealer.

Stop the operation immediately when something is wrong with this product.

When smoke goes up from the product or the smell of smoke comes from the product, continued use will result in fire, injury, or damage to the product.

- Turn off the power of this product immediately, and then contact your dealer.

Avoid placing receptacles that contain liquids such as water on/near this product.

If liquid spills onto this product, it may cause fire or an electric shock.

- If it happens, disconnect the power plug from the electric outlet immediately and contact your dealer.

Clean the power plug periodically to keep it dust free.

Dust can cause the insulation to be damaged and cause a fire.

- When cleaning, disconnect the power plug and wipe with a clean dry cloth.

Do not install this product in an unstable location.

Selecting an inappropriate installation surface may cause the product to fall down or topple over, resulting in injury.

Do not touch this product, power cord and connected cables when thunder is heard.

Failure to observe this may cause electric shock.

Do not connect/disconnect the power plug with wet hands.

Failure to observe this may cause electric shock.

Avoid doing anything that can damage the power cord/plug.

Do not damage, modify, forcefully bend, twist, stretch or bundle the power cord, and do not put a heavy thing on the power cord.

Using a damaged power cord can cause electric shock, short circuit, fire, etc.

- Contact your dealer for repair of the power cord and plug.

Grounding

Use this product after confirming that grounding is properly installed.

If grounding is not installed properly, it may cause ground leakage or damage the product resulting in electric shock.

- Contact the dealer for details. (The grounding installation cost is not included in the price of this product.)

Do not engage in work related to the installation and wiring during the power is on.

Failure to observe this may cause fire or electric shock.

Hold the power plug to disconnect the power cord.

Do not pull the power cord since it can cause fire, electric shock, etc.

Connect the power plug firmly.

If the power plug is not connected firmly, it can cause fire, electric shock, etc.

- Do not use the damaged power cord and loose electric outlets.

Do not connect to outlets or wiring device if their ratings are beyond the specified rating.

If the rating goes over the specified rating such by putting many loads on one electric outlet, it can cause generation of heat resulting in fire.

Do not strike or give a strong shock to this product

Failure to observe this may cause fire or electric shock.

Avoid placing this product in locations which are subject to humidity and dust.

Failure to observe this may cause fire or electric shock.

Do not block the ventilation holes.

Doing so can cause fire since it can raise the temperature inside this product high.

Precautions (continued)

Precautions for use

Power source

The input power source for this product is 100 V - 240 V AC 50 Hz/ 60 Hz.

Do not connect to the outlet that provides the power to equipment that requires a measurable amount of power (such as a copy machine, air conditioner, etc.). Avoid placing this product in locations where is subject to water.

* The included power cord(s) is (are) dedicated to the use with this product. Do not use with any other device. Also, do not use any other power cord with this product.

Ambient operating temperature

Use this product at temperatures between 0 °C to +45 °C. Failure to do so may damage the internal parts or cause malfunction.

* Performance and lifetime of hard disk drives are easily affected by heat (used at high temperature). It is recommended to use this product at a temperature of approx. +25 °C.

To cut the power supply

This product has no power switch. To cut the power supply, unplug the power plug of the product from the AC outlet. If the power cord cannot be unplugged easily due to installation condition, connect the power cord to an AC outlet via a distribution board circuit breaker with a cut-off capacity.

Built-in backup battery

- Do not expose the built-in battery to excessive heat such as sunlight, fire, etc.

Static electricity

When installing, maintaining, or operating this product, in order to remove the static electricity before touching, touch a metal object (steel desk, doorknob, etc.) with your hand first.

Static electricity can cause malfunction or failure of this product.

About protection against lightning

If cables are pulled in from outdoors, they may be affected by lightning. In that case, install a lightning arrester in the immediate vicinity of the unit and wire the network cable length between the unit and the lightning arrester as short as possible to avoid being affected by lightning.

Hard disk drive (HDD)

- Hard disk drives are precision devices. Handle them with care. It is possible to damage them if they are moved while their motors are still running.
- Please be forewarned that any loss of information on the HDD is not guaranteed under any circumstances.
- Do not move or install this product just after turning the power on or off (for around 30 seconds.) The hard disk drives are running.
- The HDD is consumable and the lifetime differs depending on the operational environment. Write errors may occur frequently after around 20000 hours of each HDD operation and head and motor deterioration may occur after around 30000 hours of operation. They will reach the end of their lifetime after 30000 hours of operation if they have been used at the recommended ambient temperature (approx. +25 °C).
- To prevent data loss from disk crashes, it is recommended to keep the ambient operating temperature at approx. +25 °C and to replace them after around 18000 hours of operation. You can check the operating time of each HDD in "Operation" of the "HDD information" tab under "Maintenance" under "Advanced" from the setup menu.
- When hard disk drive trouble occurs, replace it immediately. Contact your dealer about servicing.

About external storage devices (External HDD and USB memory)

- An external hard disk drive or a USB memory that is compatible with USB3.0 can be connected to the copy port to use as the external storage device.
- Use external storage devices formatted in exFAT, FAT (FAT16) or FAT32.
- External storage devices requiring password authentication or a special driver or using an encryption function cannot be used.

Prevent condensation from forming

If this happens, it can cause malfunction.

Leave it switched off for around 2 hours in the following cases.

- When this product is placed in an extremely humid place.
- When this product is placed in a room where a heater has just been turned on.
- When this product is moved from an air-conditioned room to a humid and high-temperature room.

Cleaning

- Turn the power off, and then use a soft cloth to clean this product.
- Do not use strong or abrasive detergents when cleaning the body.
- When using a chemical cloth for cleaning, read the caution provided with the chemical cloth product.

Precautions (continued)

Product disposal/transfer

Images saved on the storage device used with this product may lead to personal information leakage. When it is necessary to dispose or give this product to someone, even when for repair, make sure that there is no data on the hard disk drives.

Indication label

Refer to the indication label placed on the top cover or bottom of this product for the equipment classification and power source, etc.

About reboot of this product

In the following cases, this product will automatically reboot to continue recording.

- When the software of this product has detected the internal error and reboot becomes necessary.

Disclaimer of warranty on recorded data

i-PRO Co., Ltd. assumes no responsibility or liability, directly or indirectly, for failure of recording or editing including loss of data due to any reason or cause which does not exclude repair or maintenance of this product regardless whether the subject is hard disk or other parts.

Major operating controls and their functions

Front view

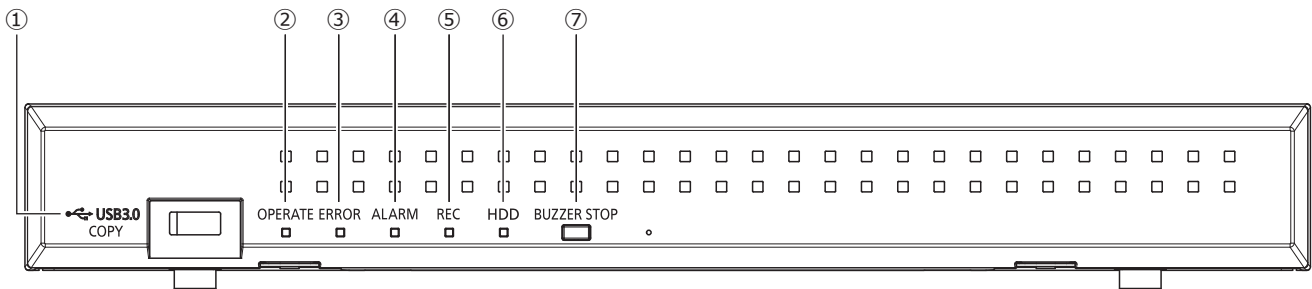

① Copy port (USB3.0) [COPY]

Connect an external storage device (external Hard disk drive, USB memory) to this port and copy images and audio recorded on the hard disk drive.

* Mouse connection is also available.

② Operation indicator [OPERATE]

Lights when the power is on.

③ Error indicator [ERROR]

Blinks when an error that can become a problem for the recorder to run the system occurs.

Blinks red: System error

Blinks orange: Thermal error, cooling fan malfunction, etc.

Shows a solid light when automatically reset from an error status.

④ Alarm indicator [ALARM]

Blinks when an alarm occurs, and lights when the alarm output stops. This indicator will go off when the [Reset] button (👉 Operating Instructions (PDF)) is clicked.

⑤ Recording indicator [REC]

Lights orange when recording is being performed.

⑥ [HDD] indicator

Indicates the operational status (access/failure) of the respective hard disk drive.

Blinks green: Indicates that the respective hard disk drive is being accessed.

Lights red: Indicates that a fault (or an error) has occurred on a hard disk drive.

Off: Indicates that the respective hard disk drive is not being accessed.

⑦ Buzzer stop button [BUZZER STOP]

Press this button to stop the buzzer that started sounding at an alarm/error occurrence. Refer to the Operating Instructions (PDF) for further information about alarms and errors.

Major operating controls and their functions (continued)

Rear view

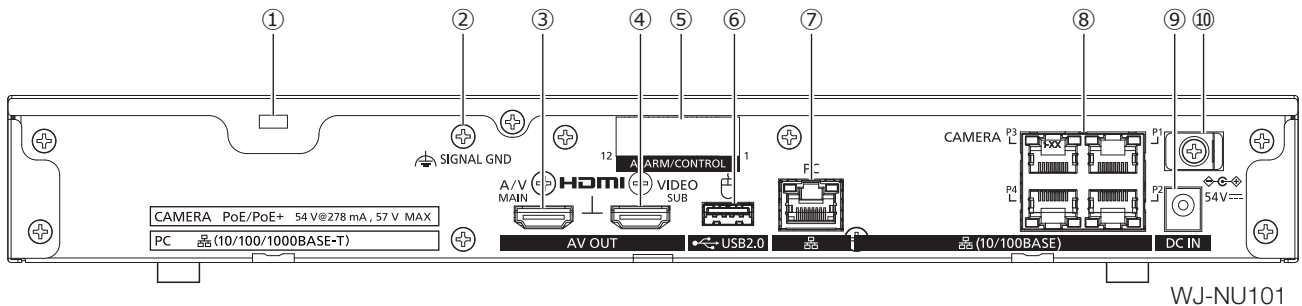

- ① **Security wire hole**
Mount the lock device for the anti-theft security wire.
- ② **SIGNAL GND terminal [SIGNAL GND]**
Connect this terminal with the SIGNAL GND terminals of the devices in the system for signal ground. When operating the recorder and the devices in the system without signal ground, noise may be produced.
- ③ **Main monitor output connector (HDMI)[A/V MAIN]**
This connector is used to connect to an HDMI-ready monitor (the main monitor). It displays live images, recorded images, or the setup menu of the recorder.
- ④ **Sub monitor output connector (HDMI)[VIDEO SUB]**
This connector is used to connect to an HDMI-ready monitor (the sub monitor). It only displays live images.
- ⑤ **Alarm/Control terminal [ALARM/CONTROL]**
It is used when connecting with an external device such as a sensor or anti-theft door switch that output alarm signals, or when connecting with an external alarm equipment such as a buzzer or a lamp.
- ⑥ **Mouse connection port (USB2.0) []**
The included mouse is connected to this port.

- ⑦ **Network port (PC port) [PC]**
Connect the recorder with a PC via a network compatible with 10BASE-T, 100BASE-TX or 1000BASE-T. The right lamp (orange) only lights up at 1000M connection. The left lamp (green) only lights up at 100M connection. Both lamps light up at 10M connection. The lamp blinks when sending or receiving data.
- ⑧ **Network port (Camera port) [CAMERA]**
Connect the recorder with a PC and cameras via a network compatible with 10BASE-T or 100BASE-TX. When the port is being accessed, the access indicator (green) blinks. When the port is supplying power, the PoE indicator (orange) lights.

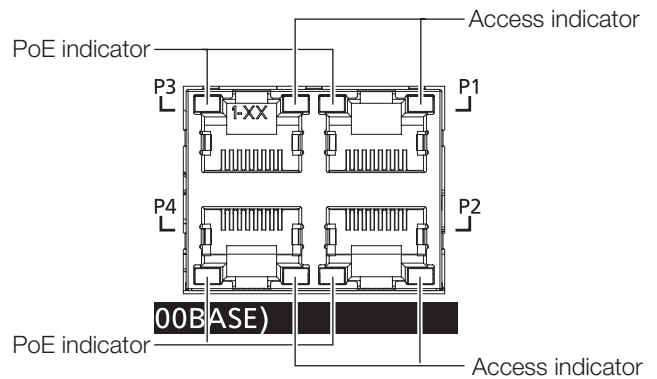

Note:

- The camera port comes with the PoE power supply function that complies with IEEE802.3at.
- The camera number detected at Easy Start does not match the camera port number (P1~P8 (P4: WJ-NU101)) on the rear panel of the recorder.

Major operating controls and their functions (continued)

⑨ DC jack [DC IN]

Connect the DC plug of the included AC power adapter. Make sure that you insert the DC plug all the way to prevent from loosening or coming off.

Secure the DC cable with a cable clamp so that the DC plug will not come off.

(Refer to "How to prevent DC plug disconnection" on this page)

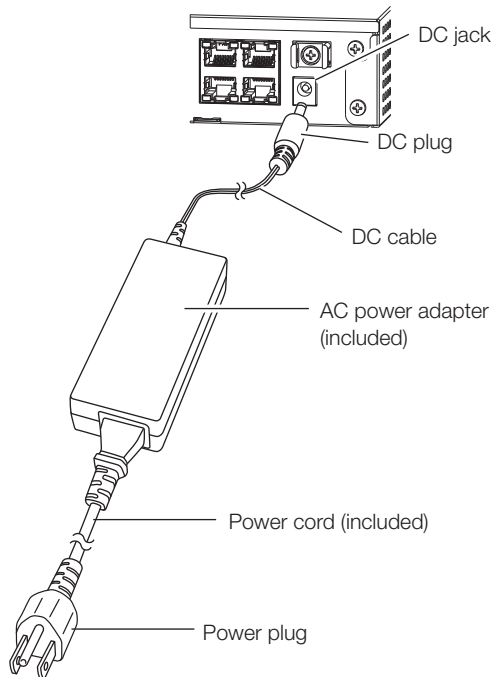

⑩ Clamp mount (To prevent power cord disconnection)

How to prevent DC plug disconnection

Fix a 10 cm ~ 15 cm {4 inches ~ 6 inches} space of the DC cable from the DC plug with the included cable clamp passed through the clamp mount.

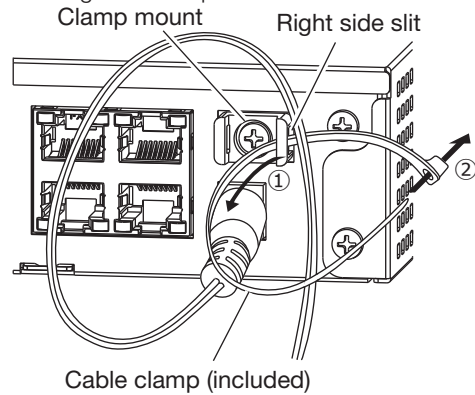

① Pass the cable clamp (included) through the right side slit of clamp mount.

② To tighten the DC cable, make a loop with the cable clamp as shown in the illustration.

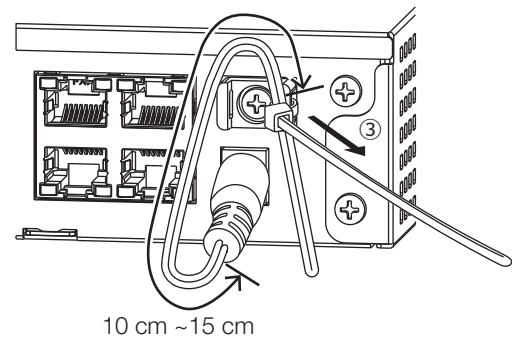

③ Tighten the DC cable at 10 cm to 15 cm {4 inches ~ 6 inches} from the DC plug and fix it to the clamp mount.

Cut the surplus part of the cable clamp as necessary.

User/Host management

It is necessary to register users who directly operate this product, or PCs (hosts) that access through the network such as LAN. Up to 32 users can be registered.

It is possible to register the following for the user information.

Item	Description
User name	User name is to be registered to log in to the recorder. The user name will be entered at the time of login.
Password	Password is to be registered to log in to the recorder together with the user name. The password will be entered at the time of login.
Level	Users are classified into the following levels depending on the available operations. Administrator/Manager/Operator/Viewer/Logged out The administrators can perform all the configurations and operations. It is possible to select in advance the functions that can be controlled by users at other levels. (☞ Operating Instructions (PDF))
Priority level	Priority level indicates the operational priority. Users at each level are assigned the fixed priorities ranging from "0" (Highest) to "4" (Low). Administrator 0 Highest Manager 1 High Operator 2 Viewer 3 Logged out 4 Low When the two or more users at the same level perform the same operation, the recorder will be controlled in accordance with the latest operation.
Default screen	Select the live image display screen of the main monitor/PC screen to be displayed immediately after login.

When operating from a PC via a network

Operation of the recorder can be made using a PC via a network. Up to 16 hosts (PCs) can access the recorder at the same time.

When another host (PC) tries to log in to the recorder after 16 hosts (PCs) have already logged in, the user with the lowest priority will be logged out. When the user who is trying to log in has the same priority as the users who have already logged in, the user whose login is the earlier is logged out.

When accessing the recorder from a PC via a network, the log-in authentication method is different as follows depending on the "User authentication" settings of the "Basic" tab under "User management" under "Advanced" from the setup menu.

(☞ Operating Instructions (PDF))

User authentication setting	User/Host to log in	Remarks
Off	Log in as an administrator.	
On (default)	Log in as a registered user.	The login window will be displayed.

Specifications

• General

Power source:	DC 54 V 1.67 A WJ-NU101 DC 54 V 2.78 A WJ-NU201, WJ-NU300
Power consumption:	When using the included AC adapter WJ-NU101 90 W (DC54 V 1.67 A) WJ-NU201 150 W (DC54 V 2.78 A) WJ-NU300 150 W (DC54 V 2.78 A)
Ambient operating temperature:	Main body: 0 °C - +45 °C {32 °F - 113 °F} Mouse (included): +5 °C - +40 °C {41 °F - 104 °F}
Ambient operating humidity:	5 % to 90 % (non condensing)
Maximum operating altitude:	2000 m {6562 feet} above sea level
Recording compression method:	H.265, H.264, JPEG
Dimensions:	W340 × D230 × H44 (mm) W13-3/8 × D9-1/16 × H1-23/32 (inches) (excluding rubber feet and projections)
Mass:	Approx. 2.1 kg {4.6 lbs} When one hard disk drive is installed: Approx. 2.7 kg {6.0 lbs}
Finish:	Front view: Solid black coating, Resin Top cover: Solid black coating, Zinc-coated steel Rear view: Zinc-coated steel

• Input/Output

Monitor (HDMI) connector:	HDMI (19 pin, type A), ×2
Main monitor	3840 × 2160 (4K) p/30 Hz 3840 × 2160 (4K) p/25 Hz 1920 × 1080 p/60 Hz 1920 × 1080 p/50 Hz
Sub monitor	1920 × 1080 p/60 Hz 1920 × 1080 p/50 Hz
Mouse connection port:	High-speed serial interface, USB2.0, ×1
Copy port:	High-speed serial interface, USB3.0, ×1
Alarm/Control connector:	Alarm input 1, 2, 3 and 4*1, Alarm output*2, Emergency recording input*1, HDD error/Recording error output*2, Camera error output*2, General purpose I/O 1 and 2*1*2, +5 V output*3
Network port (Camera):	10BASE-T/100BASE-TX (RJ-45) × 4 (WJ-NU101) 10BASE-T/100BASE-TX (RJ-45) × 8 (WJ-NU201, WJ-NU300) Power supply standard: IEEE802.3at compatible Power supply capacity: 4 port total up to 50 W (WJ-NU101) Power supply capacity: 8 port total up to 110 W (WJ-NU201, WJ-NU300)
Network port (PC):	10BASE-T/100BASE-TX/1000BASE-T (RJ-45) ×1
Security wire hole:	7 mm × 3 mm {9/32 inches × 1/8 inches}
Support protocols:	HTTP, HTTPS, RTP, RTSP, TCP/IP, UDP/IP, SMTP, NTP (Server, Client), DNS, SNMP
Support web browsers:	Microsoft Edge*4, Google Chrome™, Mozilla Firefox

*1 Non-voltage make contact input +3.3 V pull-up Approx. 23 kΩ

*2 Open collector output 24 V DC max., -200 mA max.

*3 +5 V ±0.5 V 200 mA max.

*4 Internet Explorer compatibility mode of Microsoft Edge is not supported.

Specifications (continued)

• AC power adapter (WJ-NU101, Included)

Input voltage:	100 V AC to 240 V AC 50 Hz/60 Hz
Output voltage:	DC54 V 1.67 A
Ambient operating temperature:	0 °C - +40 °C {32 °F - 104 °F}
Dimensions:	65 mm(W) × 25 mm(H) × 140 mm(D) {2-9/16 inches (W) × 31/32 inches (H) × 5-1/2 inches (D)} (excluding power cord and DC cable)
Mass:	Approx. 280 g {0.62 lbs}

• AC power adapter (WJ-NU201, WJ-NU300, Included)

Input voltage:	100 V AC to 240 V AC 50 Hz/60 Hz
Output voltage:	DC54 V 2.78 A
Ambient operating temperature:	0 °C - +40 °C {32 °F - 104 °F}
Dimensions:	76 mm(W) × 25 mm(H) × 151 mm(D) {3 inches (W) × 31/32 inches (H) × 5-15/16 inches (D)} (excluding power cord and DC cable)
Mass:	Approx. 360 g {0.79 lbs}

• Option

Rack mount bracket	WV-QRM101
Rack mount bracket (for vertical installation)	WV-QRM001
Rack mount bracket (for horizontal installation)	WV-QRM201
PoE Camera Power Unit	WJ-PU201 (For U.S.) WJ-PU201/G (For Europe) WJ-PU201F/G (For Europe)

i-PRO Co., Ltd.

Tokyo, Japan

<https://www.i-pro.com/>

Authorised Representative in EU:
i-PRO EMEA B.V.
Laarderhoogtweg 25, 1101 EB
Amsterdam, Netherlands



i-PRO EMEA B.V. UK Branch
1010 Cambourne Business Park,
Cambridgeshire CB23 6DP

